

AFTERCARE INSTRUCTIONS

Excessive exposure to water will deteriorate the furniture. Wipe away any water splashes or condensation after use.

All bathrooms should be well ventilated, if needed, with a suitable extractor fan.

Clean with a soft damp cloth only.

Use a wax free polish if one must be used.

All electrical components are IP44 rated.

Do not allow water to come into contact with the electrical components.

CUSTOMER SERVICE

t:+44 208 686 5100

e: sales@saneux.com

Iain Stewart Centre, Gatwick,
Beehive Ring Road, RH6 0PB

www.saneux.com



FRONTIER

INSTALLATION INSTRUCTIONS

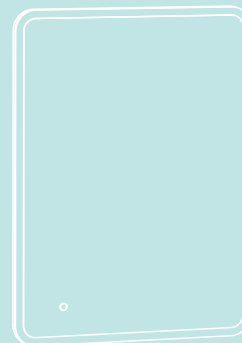



FRO60M - FR120M

saneux

Before drilling, ensure there are no hidden cables or pipes in the wall.

Throughout the entirety of the installation process, make sure that the domestic electrical mains supply to which the product is being connected is turned off.

-  x5 Ø4 x 40mm Screw
-  x5 Ø7.5 x 35mm Wall plug

WIRING DIAGRAM

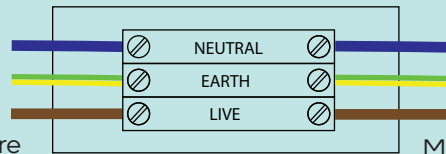

- The Neutral supply can be Blue or Black.
- The Earth supply is Green and Yellow.
- The Live supply cable can be Red or Brown.

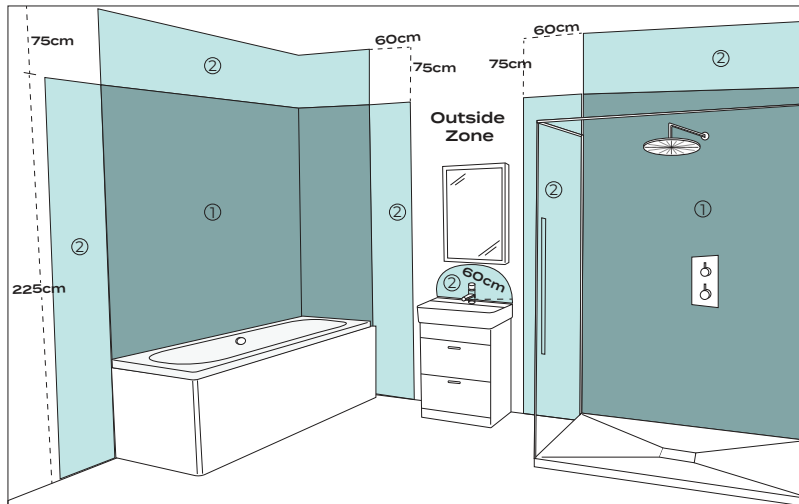

All electrical bathroom products should be fitted by a qualified electrician.

This product is suitable for 'Zone 2 & Outside zone' indicated in the image above.

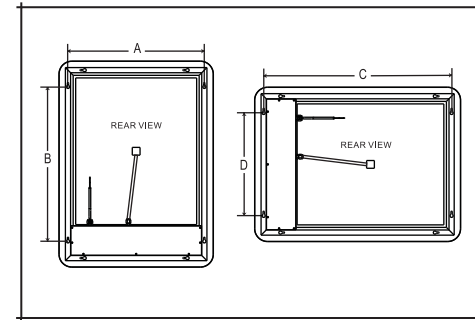

Measure distance A & B or C & D. Mark the 4 points on the wall, ensuring that the holes are level.
NOTE: Check there are no hidden pipes or cables behind the wall before drilling.

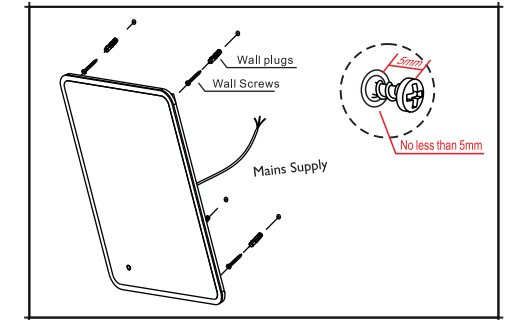

Drill holes and fix the wall plugs and screws in place, leaving 5mm of the screw head protruding from the wall.

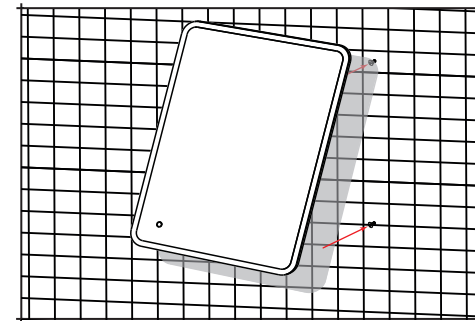

Before hanging the mirror make the electrical connection at the rear of the mirror.
Carefully hang the mirror in place, locating the holes onto the screws. Ensure the mirror is fully secured onto the mounting holes before letting go.

- To operate the mirror:
- Press the touch sensor once to switch on
- Press the touch sensor again to switch off
- To adjust the colour from cold white to warm white and visa versa hold the touch sensor down.

